

CARDALE MK2 LEVEL ACCESS SHOWER

HOW TO ORDER

1 CHOOSE SHOWER TRAY SIZE

2 CHOOSE A COMBINED TRAY & DOOR KIT OPTION (this is a complete kit)

P3 Integral waste pump included as standard (& shown on p50)

Door and enclosure kit contents:

Door kit (c/w rising butt hinge on Trifold door)
 Half height fixed panel
 Assistance pole (1830mm) to Curtain Rail (floor to Ceiling poles are available as an option - additional £15. Please confirm height requirement)
 Curtain Track and Hooks to suit door option
 White Shower Curtain
 Fitting instructions
 See p143 for Shower units (optional extra) (electric shower recommended)

Shower tray contents:

White shower tray
 Tray Edging Cover Strip
 Fitting instructions

IMPORTANT NOTE: Trays and door kits on this page are supplied under one code as a complete kit.

LEFT HAND TRAY To order tick the relevant circle and fax back.

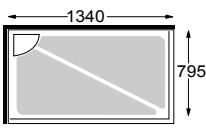
1 SHOWER TRAY SIZE		2 SHOWER TRAY/ TRIFOLD DOOR KIT	SHOWER TRAY/ TRIFOLD DOOR KIT & HALF HEIGHT PANELS	SHOWER TRAY/ TRIFOLD DOOR KIT & FULL HEIGHT PANELS	SPECIAL DOOR KIT
LEFT HAND TRAY 	Order as a P3 complete tray & door kit using part no's shown right. Waste detail shown on p50.	<input type="radio"/> 00-080713301 	<input type="radio"/> 00-080713302 	<input type="radio"/> 00-080713303 	<input type="radio"/> SEE PAGE 67 

Please note:

Tray must be installed 1240mm tile to tile

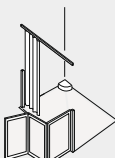
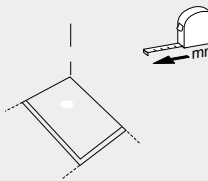
2 TRIFOLD DOOR KIT (ALCOVE INSTALLATION)	SPECIAL DOOR KIT
<input type="radio"/> 00-080713304 	<input type="radio"/> SEE PAGE 67 

PARTS

LEFT HAND CARDALE MK2

Notes:
For shower tray part number see below

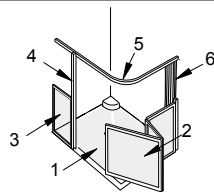

TRIFOLD
DOOR KIT

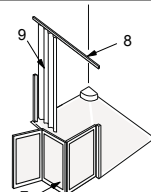

ALCOVE
DOOR KIT

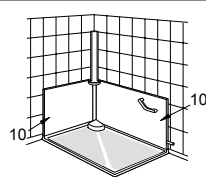

LEFT HAND CARDALE MK2 PANELS

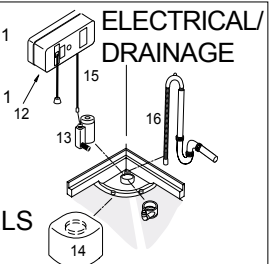
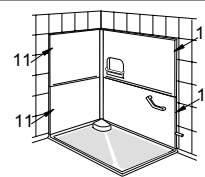

ELECTRICAL/
DRAINAGE

PART NUMBER	DESCRIPTION	PART NUMBER	DESCRIPTION
<input type="radio"/> IDIC05	1. Tray	<input type="radio"/> IDICP01	10. Half height wall panels
<input type="radio"/> 02-100233304	2. Door (Trifold)	<input type="radio"/> IDICP05	11. Full height wall panels
<input type="radio"/> 03-040213303	3. Jamb panel		
<input type="radio"/> 04-030013001	4. Pole set		
<input type="radio"/> IDGRL5129W	5. Curtain rail		
<input type="radio"/> IDGSS22	6. Curtain		
ALCOVE MODEL		ELECTRICAL COMPONENTS/DRAINAGE (TO SUIT ALL KITS)	
<input type="radio"/> 02-100233303	7. Alcove (RH door)	<input type="radio"/> SHSU050	12. Wiring block
<input type="radio"/> IDGRS72W	8. Curtain rail	<input type="radio"/> SHPU032	13. Pump
<input type="radio"/> IDGSS01	9. Curtain	<input type="radio"/> SH0695W	14. Pump cover
		<input type="radio"/> SHPU004/12v	15. Rewire lead
		<input type="radio"/> SHSU019	16. Flexihose

SYMBOLS:

Bulk/oversized item



Made to order (see P200)



Tel: 0800 917 0399

www.chilterninvadex.co.uk

Fax: +44 (0) 1869 365588

sales@chilterninvadex.co.uk

CARDALE MK2 LEVEL ACCESS SHOWER

HOW TO ORDER

- 1 CHOOSE SHOWER TRAY SIZE**
- 2 CHOOSE A COMBINED TRAY & DOOR KIT OPTION (this is a complete kit)**
- P3** Integral waste pump included as standard (& shown on p50)

Door and enclosure kit contents:
 Door kit (c/w rising butt hinge on Trifold door)
 Half height fixed panel
 Assistance pole (1830mm) to Curtain Rail
 (floor to Ceiling poles are available as an option - additional £15. Please confirm height requirement)
 Curtain Track and Hooks to suit door option
 White Shower Curtain
 Fitting instructions
 See p143 for Shower units (optional extra)
 (electric shower recommended)

Shower tray contents:
 White shower tray
 Tray Edging Cover Strip
 Fitting instructions

IMPORTANT NOTE: Trays and door kits on this page are supplied under one code as a complete kit.

RIGHT HAND TRAY To order tick the relevant circle and fax back.

1 SHOWER TRAY SIZE		2 SHOWER TRAY/ TRIFOLD DOOR KIT	SHOWER TRAY/ TRIFOLD DOOR KIT & HALF HEIGHT PANELS	SHOWER TRAY/ TRIFOLD DOOR KIT & FULL HEIGHT PANELS	SHOWER TRAY/ SPECIAL DOOR KIT
RIGHT HAND TRAY 	Order as a P3 complete tray & door kit using part no's shown right. Waste detail shown on p50.	<input type="radio"/> 00-080733301 	<input type="radio"/> 00-080733302 	<input type="radio"/> 00-080733303 	<input type="radio"/> SEE PAGE 67 

Please note:
 Tray must be installed 1240mm tile to tile

2 TRIFOLD DOOR KIT (ALCOVE INSTALLATION)		SPECIAL DOOR KIT
<input type="radio"/> 00-080733304 		<input type="radio"/> SEE PAGE 67 

PARTS

RIGHT HAND CARDALE MK2

Notes:
For shower tray part number see below

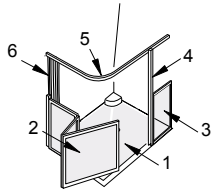

TRIFOLD DOOR KIT

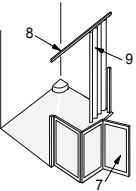

ALCOVE DOOR KIT

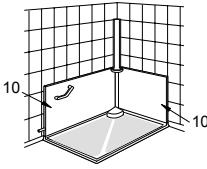

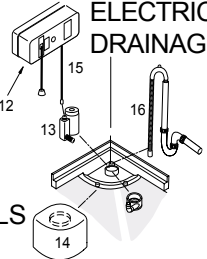

RIGHT HAND CARDALE MK2 PANELS



ELECTRICAL/ DRAINAGE

PART NUMBER	DESCRIPTION	PART NUMBER	DESCRIPTION
<input type="radio"/> IDIC07	1. Tray	<input type="radio"/> IDICP03	10. Half height wall panels
<input type="radio"/> 02-100213304	2. Door (Trifold)	<input type="radio"/> IDICP07	11. Full height wall panels
<input type="radio"/> 03-040233303	3. Jamb panel		
<input type="radio"/> 04-030033001	4. Pole set		
<input type="radio"/> IDGRL5129W	5. Curtain rail		
<input type="radio"/> IDGSS22	6. Curtain		

ALCOVE MODELS		ELECTRICAL COMPONENTS/DRAINAGE (TO SUIT ALL KITS)	
<input type="radio"/> 02-100213303	7. Alcove (LH door)	SHSU050	12. Wiring block
<input type="radio"/> IDGRS72W	8. Curtain rail	SHPU032	13. Pump
<input type="radio"/> IDGSS01	9. Curtain	SH0695W	14. Pump cover
		SHPU004/12v	15. Rewire lead
		SHSU019	16. Flexihose

SYMBOLS:
 Bulk/oversized item 
 Made to order (see P200) 

Tel: 0800 917 0399 Fax: +44 (0) 1869 365588
 www.chilterninvadex.co.uk sales@chilterninvadex.co.uk